

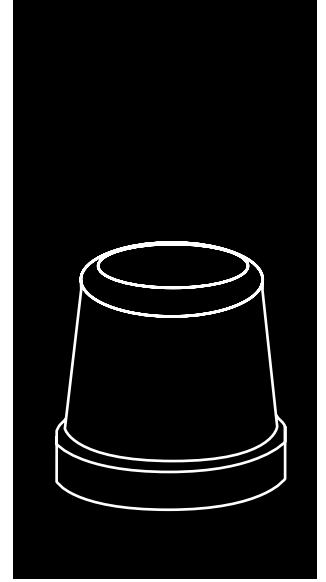









ELEGANCE ICE 230 V / 50 Hz

DOMESTIC ICE MACHINE

FEATURES CARACTERÍSTICAS

- ▶ **PRODUCE PROFESSIONAL 22 GRS GOURMET CRYSTAL ICE CUBES**
PRODUCE CUBITOS PROFESIONALES DE HIELO GOURMET CRISTALINOS 22 GRS
- ▶ **BLACK STAINLESS-STEEL BODY ADDS A TOUCH OF LUXURY TO ANY SPACE.**
CARROCERÍA DE ACERO INOXIDABLE NEGRO QUE AÑADE UN TOQUE DE LUJO A CUALQUIER ESPACIO.
- ▶ **ANTI-FINGERPRINT SURFACE TO ENSURE A FLAWLESS, STREAK-FREE APPEARANCE EVERY TIME.**
SUPERFICIE ANTIHUELLAS PARA GARANTIZAR UNA APARIENCIA SIEMPRE IMPECABLE Y LIBRE DE MARCAS.
- ▶ **DESIGNED FOR HOME APPLICATIONS**
DISEÑADA PARA APLICACIONES DOMESTICAS
- ▶ **ON/OFF PROGRAMABLE**
HORA DE ENCENDIDO Y APAGADO PROGRAMABLE
- ▶ **NATURAL GAS R290 WITH VERY LOW GLOBAL WARMING POTENTIAL WHICH ALSO REDUCES THE ENERGY CONSUMPTION**
GAS NATURAL R290 CON MUY BAJO ÍNDICE GWP EL CUAL TAMBIÉN REDUCE EL CONSUMO ENERGÉTICO



	 24 H	 10°C (Kg)	 10°C (Kg)	 21°C (Kg)	 15°C (Kg)	 STOCK (Kg)	 (mm)	 (mm)	
ELEGANCE ICE 		15	13	8			Width 458 Depth 575 Height 595	Width 588 Depth 680 Height 680	GALA 22gr 35 (Ø) x 35 mm (H) <small>*Average dimensions Dimensiones promedio</small>

ACCESSORIES ACCESORIOS

INCLUDED



WATER INLET HOSE
MANGUERA DE ENTRADA DE AGUA



WATER OUTLET HOSE
MANGUERA DE SALIDA DE AGUA



WATER INLET FILTER GASKET
JUNTA DE FILTRO DE ENTRADA DE AGUA



SMALL SCOOP
PALA PEQUEÑA

OPTIONAL (NOT INCLUDED)



ANTI-LIMESCALE FILTER
FILTRO ANTICAL



PARTICLE FILTER
FILTRO ANTIPARTICULAS



ANTI-CHLORINE FILTER
FILTRO ANTICLORO



ANTI-LIMESCALE + ANTI-CHLORINE FILTER CS101
FILTRO ANTICAL + ANTICLORO CS101



ELEGANCE ICE

REAR VIEW
VISTA TRASERA

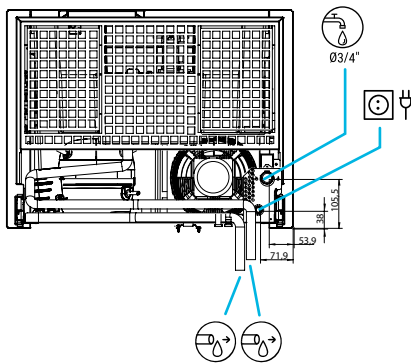

RIGHT SIDE VIEW
VISTA LATERAL DERECHA

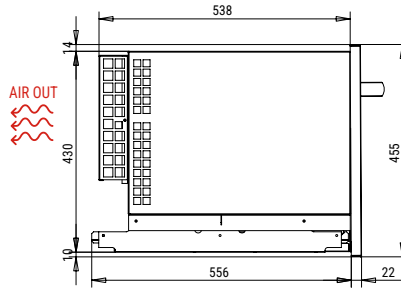

FRONTAL VIEW
VISTA FRONTAL

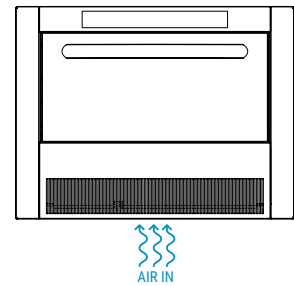

FLOOR VIEW
VISTA PLANTA

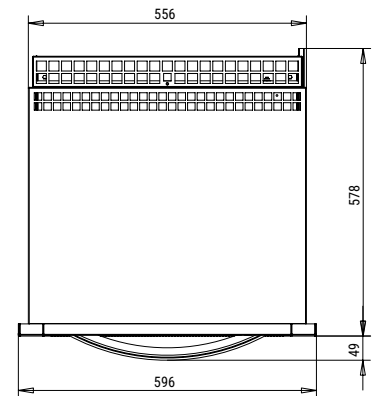

* All measurements in mm.
* Todas las cotas en mm.

OPERATING CONDITIONS CONDICIONES DE OPERACIÓN

PRODUCTION 50Hz PRODUCCIÓN 50 Hz

±10% V

5°C/43°C

5°C/35°C

1 bar/6 bar

12 Ice cubes/cycle

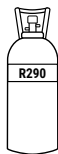

V	Hz	ph
230	50	1N



ELEGANCE ICE AIR COOLED

	10°	15°	21°	30°
	50°	60°	70°	86°
10°	15	14	13	11
50°	14	13	12	10
21°	11	10	10	9
68°	9	8	8	8
32°				
90°				
43°				
109°				

MODELS MODELOS

ELEGANCE ICE

ASHRAE CONDITIONS CONDICIONES ASHRAE	ASHRAE CONDITIONS CONDICIONES ASHRAE	ASHRAE CONDITIONS CONDICIONES ASHRAE	ASHRAE CONDITIONS CONDICIONES ASHRAE	ASHRAE CONDITIONS CONDICIONES ASHRAE	ASHRAE CONDITIONS CONDICIONES ASHRAE	ASHRAE CONDITIONS CONDICIONES ASHRAE	ASHRAE CONDITIONS CONDICIONES ASHRAE	ASHRAE CONDITIONS CONDICIONES ASHRAE	ASHRAE CONDITIONS CONDICIONES ASHRAE	ASHRAE CONDITIONS CONDICIONES ASHRAE	ASHRAE CONDITIONS CONDICIONES ASHRAE	ASHRAE CONDITIONS CONDICIONES ASHRAE	ASHRAE CONDITIONS CONDICIONES ASHRAE
(W)	(BTu/h)	(W) 43°C	(n.)	(mm ²)	FUSE	(Kwh)	(l/h)	HEAT REJECTED (W)	(BTu/h)	(Kg)	(Kg)	(m ³)	
418	1.426	203	3	1,5	10	32	1,8	300	1.024	40	46	0,27	



ITV ICE MAKERS, S.L.
POL. IND. SECTOR 13, AVDA. DELS HOSTALERS, 2
46394 RIBARROJA DE TURIA, VALENCIA, SPAIN
PHONE: +34 96 166 75 75 | FAX: +34 96 166 81 00
info@itv.es | www.itv.es



SERVICE
SERVICIO ASISTENCIA TÉCNICA
service@itv.es
Skype: ITV.Service
+34 961 667 639
8:00AM | 7:00PM



Subject to certain limitations
and exclusions. Only spare parts.
Sujeto a limitaciones y exclusiones.
Solo piezas de repuesto.



9001
14001

